

BL6-S301
6" Super-thin Square LED
Recessed Panel Light

Catalog #		Prepared by LiteHarbor	
Project		Date	
Notes			

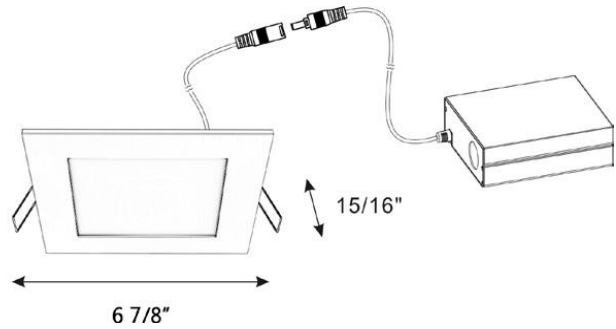

6" Super-thin Square LED Recessed Panel Light

Description

This ultra thin recessed LED Panel is absolutely perfect for tight spaces, soffits and insulated and dropped ceilings.

Recessed 6" Square LED panel with integral driver In connection box. Fits where no other recessed fixture can.

This LED is 12 watts and replaces a 65 watt halogen Save up to 80% energy for same light output.

The thin Panel profile with spring clips allows for quick and easy installation. Ideal for confined spaces and suitable for damp locations

Features

Available in all 6" Square openings.

Retrofit or New Construction

Install Directly Under Joists, Maximum Layout

Flexibility

Comes with Junction Box & Driver, No Housing Required

Fast & Easy To Install

A B C D E F G

Item No.: BL6-S301

A	Series
BL6-S301	6" Square & Remodel
BL6-S301-NC	6" Square & New Construction

B	Input Voltage
	120V
277	277V
U	120-347V

C	Color Temperature
27	2700K
30	3000K
40	4000K



PANEL LIGHT



Liteharbor Lighting Technology Co., Ltd.
 New Industry Area Hecun Danzao Town
 Nanhai Foshan City Guangdong China

TEL: +86-757-8180 8675
 FAX: +86-757-8180 8685
 E-mail: info@liteharbor.com

Website: www.liteharbor.com
 Specifications subject to change w/o notice
 Revision: Jan. 2016

Mounting

Cut Hole In Ceiling And Snap Fixture In Opening
With Attached Spring Clips. Space in ceiling needed
for the driver to fit through the hole – 1 1/2" .

Trim Option



Appearance



Light Distribution Curve

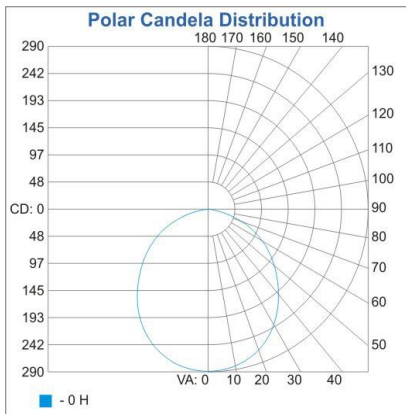

Illuminance at a Distance		
Center Beam FC		Beam Width
3.3ft	26.5 fc	8.7ft
6.7ft	6.44 fc	17.7ft
10.0ft	2.89 fc	26.4ft
13.3ft	1.63 fc	35.1ft
16.7ft	1.04 fc	44.0ft
20.0ft	0.72 fc	52.7ft

■ Vert. Spread: 105.6

Note: The Curves indicate the illuminated area and the average illumination at a set distance from the LED Down Light.

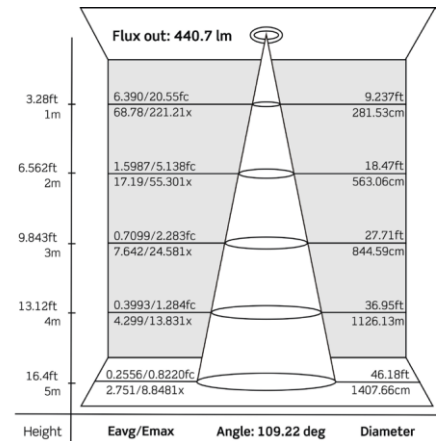

D	Dimmable
	Non-Dimmable
DM	Dimmable

E	Finish
WH	White
BK	Black
SN	Satin Nickel

F	Mounting
	Remodel
	New Construction

G	Trim
	Trimmed
	Trimless



PANEL LIGHT



Liteharbor Lighting Technology Co., Ltd.
New Industry Area Hecun Danzao Town
Nanhai Foshan City Guangdong China

TEL: +86-757-8180 8675
FAX: +86-757-8180 8685
E-mail: info@liteharbor.com

Website: www.liteharbor.com
Specifications subject to change w/o notice
Revision: Jan. 2016

Specification

Applications	Recessed Ceiling Mount
Wattage	12W
Light Output	1000lm
CRI	82+
CCT	3000K-4000K
Driver Input	120V AC or 277V-347V AC 50/60 Hz
Power Factor	0.98
Dimming	TRIAC Dimmers 10%-100% (120V only)
Location	Insulated Ceiling & Damp Locations
Lifespan	50,000 Hours at 70% Light Output
Certification	ETL
Warranty	5 Year Limited for Fixture & Driver

Packing

CTN Size:480X375X205mm

Inner Box Size: 180X75X180mm

12PCS/CTN

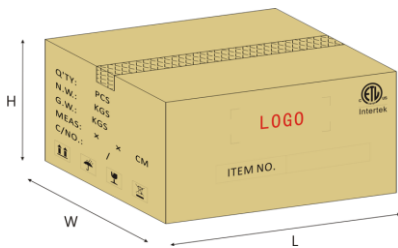

Installation Instructions

1. Turn power OFF from the electrical panel prior to installation.
2. Determine the location for installation and cut ceiling hole in accordance with cut-hole dimensions. Refer to *Hole Diameter* table for appropriate sizes. (Fig. 1)
3. Open the junction box cover and remove the appropriate knockout(s) on the side panel. (Fig. 2)
4. Insert the electrical supply cable through the knockout and secure with a cable connector (sold separately).
5. Using quick-connect push-in terminals, connect the ground wire to the green wire terminal; black wire to black wire terminal; white wire to white wire terminal. (Fig. 2)

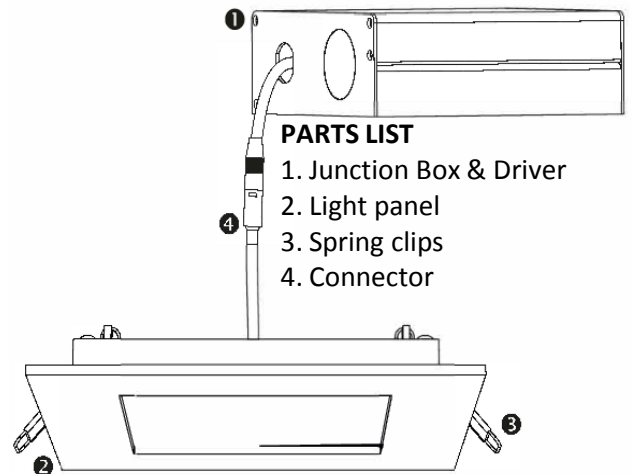
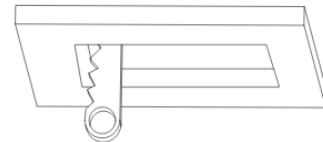

Fig. 1



Hole diameter/Diamètre de perforation:

PROF41 (4")	4 1/4" x 4 1/4" ± 1/8" (110 x 110 ± 3mm)
PROF61 (6")	6 1/4" x 6 1/4" ± 1/8" (159 x 159 ± 3mm)

Fig. 2

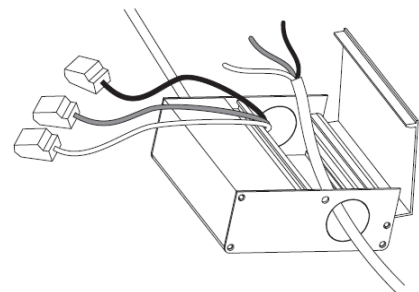

Liteharbor Lighting Technology Co., Ltd.

New Industry Area Hecun Danzao Town
Nanhai Foshan City Guangdong China

TEL: +86-757-8180 8675

FAX: +86-757-8180 8685

E-mail: info@liteharbor.com

Website: www.liteharbor.com

Specifications subject to change w/o notice

Revision: Jan. 2016

6. Place all wiring and connections back in to the box and close the cover. Connect the driver to the light panel.

7. Insert junction box through the mounting hole. (Fig. 3)

8. Push spring-loaded clips on the fixture upwards and insert fixture base in to the mounting hole. Release the clips and fixture will be pulled flush to the ceiling. (Fig. 4)

Fig. 3

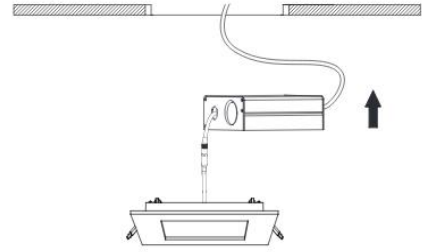

Fig. 4

