

G4013A-15-W-NC MINI MULTIPLE DOWNLIGHT

Catalog #		Prepared by	LiteHarbor
Project		Date	
Notes			



Trimmed



Trimless



New Construction Wall Wash Mini LED Multiple Downlight with 15 Lamps

Description

The Mini Multiple Downlight Series is equipped with 5, 10 and 15 lamps. The miniaturized design, die-cast aluminum body, and high-performance acrylic diffuser provide uniform scientific light output for maximum visual comfort. It can illuminate the whole wall without any shadow.

Miniaturized recessed rectangular luminaire with LEDs. Main body with die-cast aluminium radiant surface, version with perimeter surface frame. Asymmetrical optic system designed to achieve an effective wall washer distribution. Flux enhancer - superpure aluminium reflector - screen in PMMA with ribbed texture; a special film in acrylic material, combined with the screen, allow for a uniform and effective light emission on the wall. Black polycarbonate internal perimeter frame. Supplied with electronic control gear connected to the luminaire.

Features

- Revolutionary narrow recessed downlight available in slim trim or trimless.
- The simplified retrofit installation can be used in both new and existing spaces.
- Dimmable with a variety of commonly used drivers.
- Life Rated for 50,000 hours at 70% lumen maintenance.
- Easy installation for new construction and remodel applications.

Specification

- Luminaire efficacy: 65 to 80lm/W
- Source: White LED module (LM-80 tested) 2700K~6000K CRI>90



Liteharbor Lighting Technology Co., Ltd.
New Industry Area Hecun Danzao Town
Nanhai Foshan City Guangdong China

TEL: +86-757-8180 8687
FAX: +86-757-8180 8685
E-mail: info@liteharbor.com

Website: www.liteharbor.com
Specifications subject to change w/o notice
Revision: Jun. 2019



- Lumen maintenance: 90% of initial lumens at 50 000 hours (L90) (LM79 tested)
- Optics: Low luminance: Spot optic, with pptibeam technology
- Material: Body and Heat sink: Die-cast aluminum, Reflector and Baffle: Thermoplastic
- Mounting: New construction installation or remodel installation
- Electrical: High efficiency electronic driver, rated at 50 000 hours
- Weight: 0.1 to 2.42lbs (0.05 to 1.1kg)
- Warranty: 3 year limited warranty.

Listing / Warranty

ETL listed to US and Canadian standards for damp location W/Feed through.
3 Year Limited Warranty.

Applications

Suitable for jewelry stores, boutiques, luxury goods stores, shopping malls and other places that require concentrated lighting and accent lighting.

Parameter

Wattage	2W/Lamp
Lumen	65-80lm/W
Optics	30°
CCT	2700K ~ 6000K
Material	Die-cast Aluminum
Dimming	Non/TRIAC/0~10V
Finish	White/Black/Silver

Ceiling Cut Hole

Lamp	5 Lamps	10 Lamps	15 Lamps
Cut-out Size	1½" x 5½" (37x 141mm)	1½" x 10¾" (37x 274mm)	1½" x 16" (37x 406mm)



Dimensions

① Trimmed:

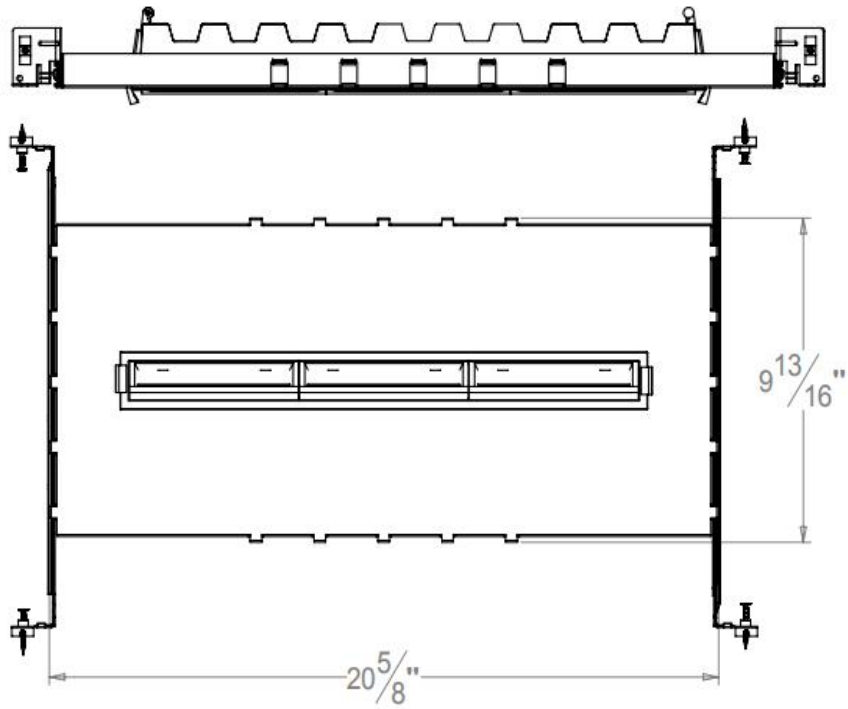

② Trimless:

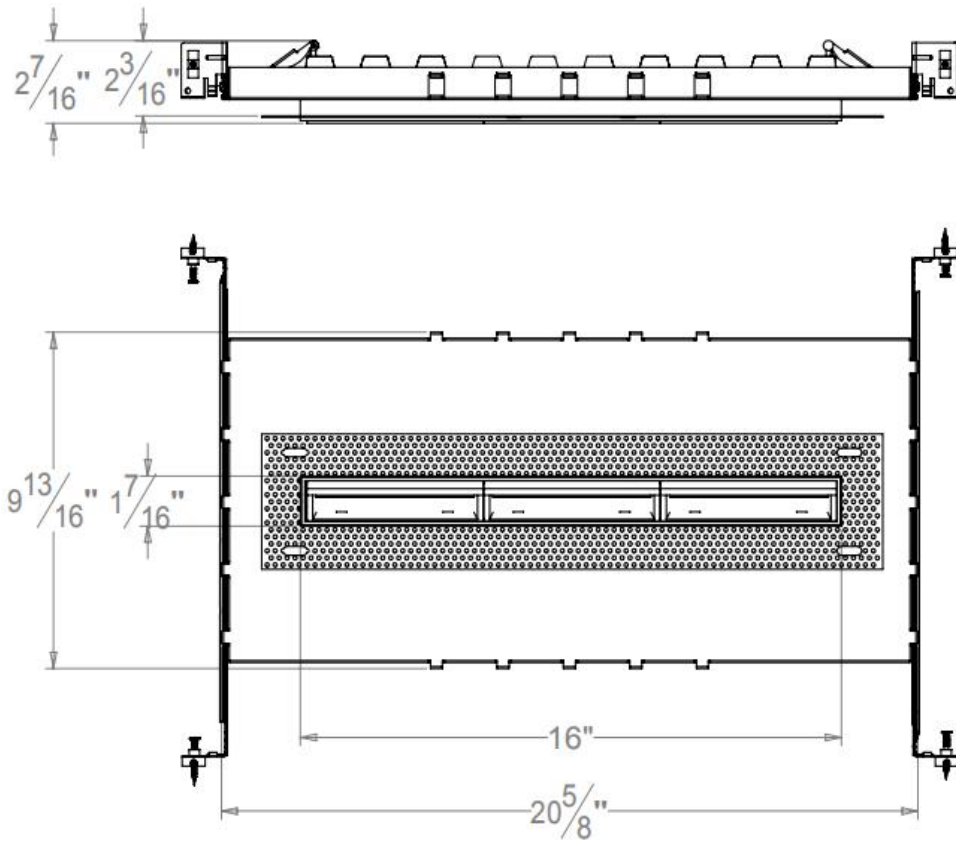

Liteharbor Lighting Technology Co., Ltd.
New Industry Area Hecun Danzao Town
Nanhai Foshan City Guangdong China

TEL: +86-757-8180 8687
FAX: +86-757-8180 8685
E-mail: info@liteharbor.com

Website: www.liteharbor.com
Specifications subject to change w/o notice
Revision: Jun. 2019



Trim Option



① Trimmed



② Trimless

Ordering Guide

Series/Lumen	Input Voltage	CCT/CRI	Dimming
<input type="checkbox"/> G4013A-15-W-NC/1950lm	<input type="checkbox"/> 120V	<input type="checkbox"/> 3000K/90+	<input type="checkbox"/> Non-dimming
New Construction Mini	<input type="checkbox"/> 230V	<input type="checkbox"/> 4000K/90+	<input type="checkbox"/> TRIAC Dimming
LED Multiple Downlight	<input type="checkbox"/> 277V	<input type="checkbox"/> 5000K/90+	<input type="checkbox"/> 0~10V Dimming
	<input type="checkbox"/> 120-277V AC		
Trim	Finish	Reflector	
<input type="checkbox"/> Trimmed	<input type="checkbox"/> White	<input type="checkbox"/> White	
<input type="checkbox"/> Trimless	<input type="checkbox"/> Black	<input type="checkbox"/> Black	
	<input type="checkbox"/> Silver	<input type="checkbox"/> Chrome	
		<input type="checkbox"/> Gold	

*Other special requirements please confirm with our factory

Notes:

1. In order to ensure normal operation of the product, please ensure that the voltage used is within the marked voltage range.
2. Please install and use the product in the correct way.
3. Please turn off the power to avoid the risk of electric shock when installing or removing product.
4. Do not look directly at LED light source for a long time, high intensity light source may cause eye injury.
5. If you find any of the following problems, please ask a qualified electrician for repair service. Do not disassemble it at will:
 - ① When the product produces odorous gas, abnormal sound or unusual flashing.
 - ② When the shell is damaged and foreign bodies invade the interior.



Liteharbor Lighting Technology Co., Ltd.

New Industry Area Hecun Danzao Town
Nanhai Foshan City Guangdong China

TEL: +86-757-8180 8687

FAX: +86-757-8180 8685

E-mail: info@liteharbor.com

Website: www.liteharbor.com

Specifications subject to change w/o notice

Revision: Jun. 2019

