

**BL2-001-NC
LED DOWNLIGHT**

Catalog #		Prepared by	LiteHarbor
Project		Date	
Notes			

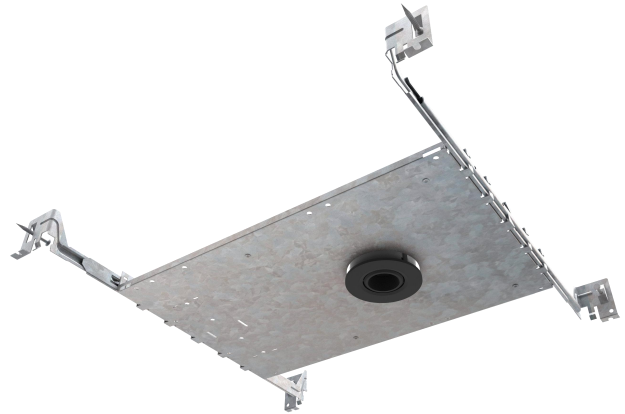

White



Black

New Construction 2 Inch Light Emitting Surface Round Miniature LED Recessed Downlight

Features

- The simplified retrofit installation can be used in both new and existing spaces.
- IC Airtight for use with direct contact to insulation.
- Beam Angle: 30/60/90 Degrees.
- Life Rated for 50,000 hours at 70% lumen maintenance.
- Easy installation for new construction and remodel applications.

Specification

- Source: LED COB Chips.
- Lumen maintenance: 50,000 hours L70 based on LM80 standardized test results.
- Optics: PC Lens for even lumen distribution.
- Material: Die-cast aluminum construction for lasting quality.
- Mounting: New construction installation or remodel installation
- Electrical: High efficiency electronic driver, rated at 50 000 hours
- Heat dissipation: Superior Thermal Management by utilizing aluminum body as heat sink.
- Warranty: 3 year limited warranty.

LED DOWNLIGHT



Liteharbor Lighting Technology Co., Ltd.
 New Industry Area Hecun Danzao Town
 Nanhai Foshan City Guangdong China

TEL: +86-757-8180 8687
 FAX: +86-757-8180 8685
 E-mail: info@liteharbor.com

Website: www.liteharbor.com
 Specifications subject to change w/o notice
 Revision: Jul. 2019

Listing / Warranty

ETL listed to US and Canadian standards for damp location W/Feed through.

3 Year Limited Warranty.

Applications

Suitable for jewelry stores, boutiques, luxury goods stores, shopping malls and other places that require concentrated lighting and accent lighting.

Parameter

Voltage	AC/DC 12V
Frequency	60 Hz
Watt	8W
Driver	Liteharbor
Dimmable	Non-dimming
Lumen	800-1000lm
Light Source	COB
CRI	90+
Beam Angle	30D/60D/90D
CCT	2700K-5000K
Material	Aluminum
Finish	White/Black/Brown



LED DOWNLIGHT



Liteharbor Lighting Technology Co., Ltd.

New Industry Area Hecun Danzao Town
Nanhai Foshan City Guangdong China

TEL: +86-757-8180 8687

FAX: +86-757-8180 8685

E-mail: info@liteharbor.com

Website: www.liteharbor.com

Specifications subject to change w/o notice

Revision: Jul. 2019

Dimensions

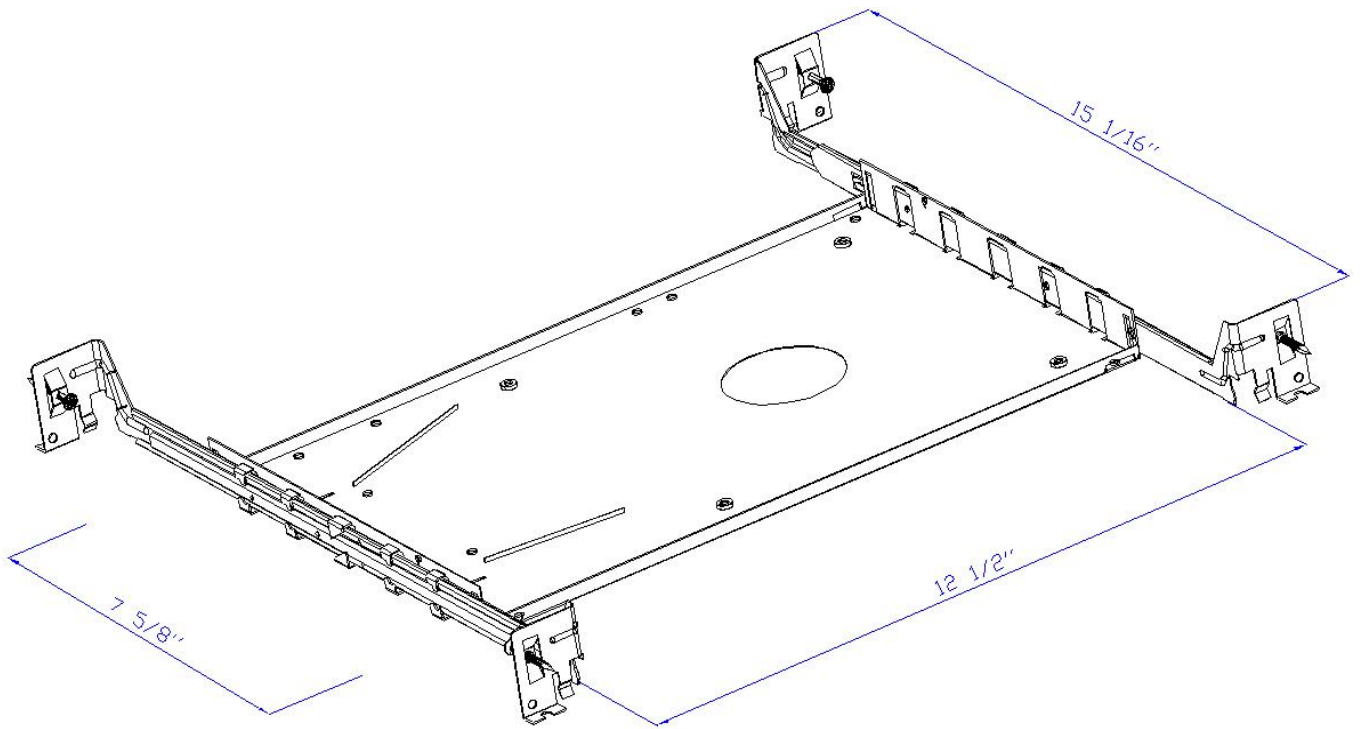

Trim Option

Option ①: Color

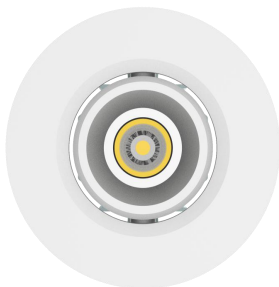

White

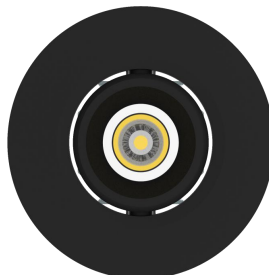

Black

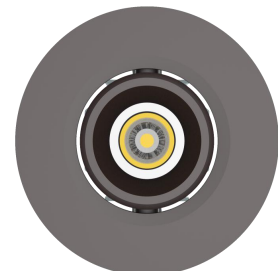

Brown

Option ②: Smooth Trim

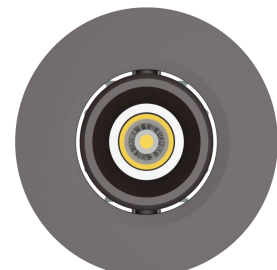
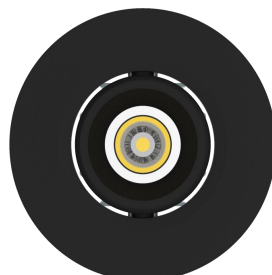
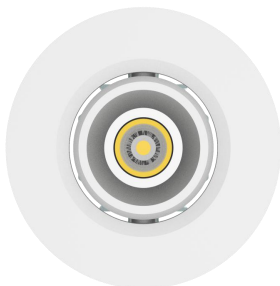

Option ③: Baffle Trim

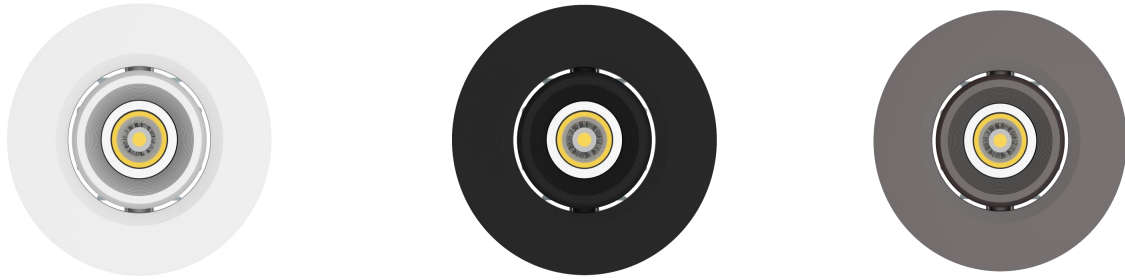

Structure Elucidation

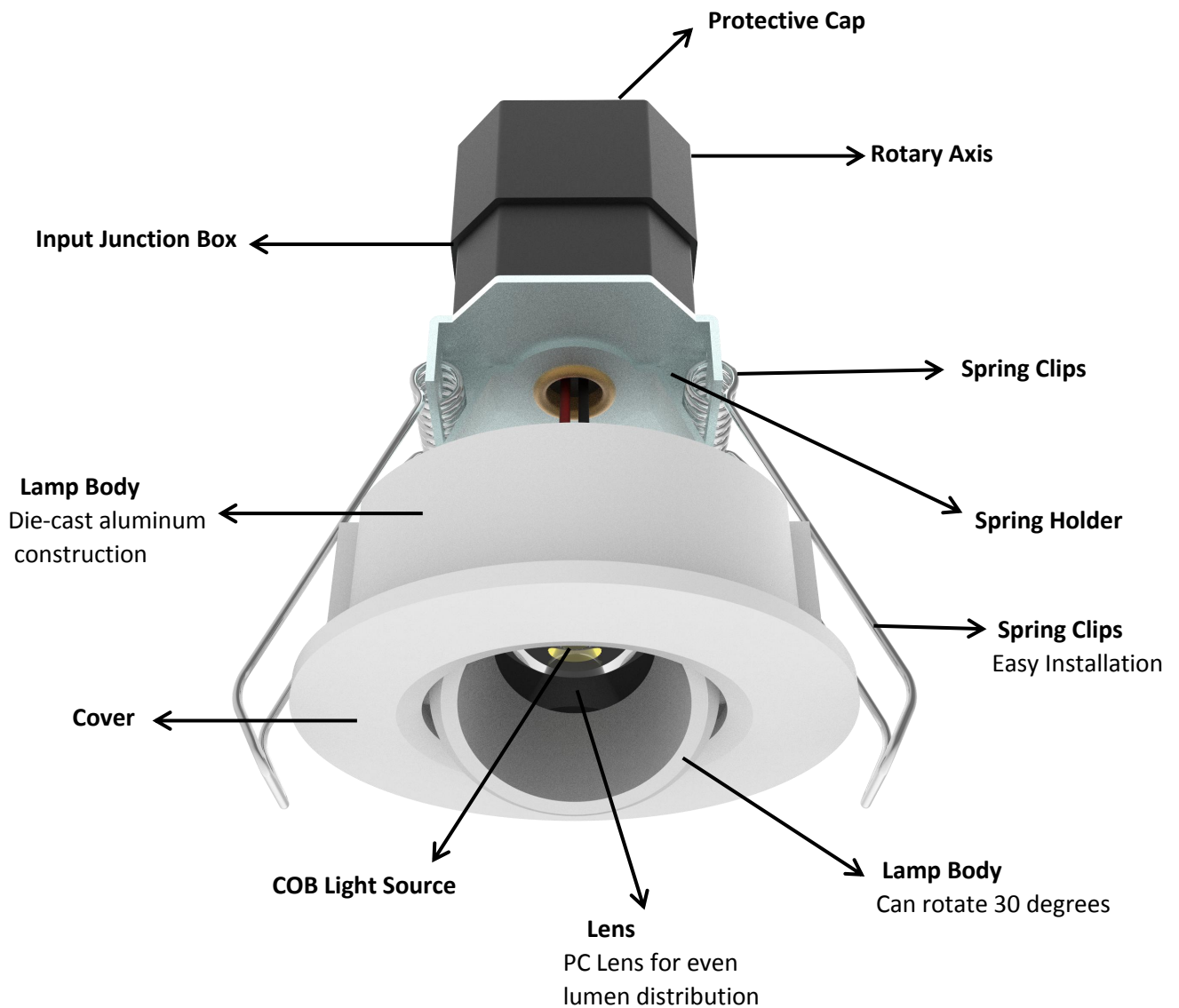

LED DOWNLIGHT



Liteharbor Lighting Technology Co., Ltd.
New Industry Area Hecun Danzao Town
Nanhai Foshan City Guangdong China

TEL: +86-757-8180 8687
FAX: +86-757-8180 8685
E-mail: info@liteharbor.com

Website: www.liteharbor.com
Specifications subject to change w/o notice
Revision: Jul. 2019

Ordering Guide

Series/Lumen	Input Voltage	CCT/CRI	Finish
<input type="checkbox"/> BL2-001-NC LED Downlight	<input type="checkbox"/> AC 12V <input type="checkbox"/> DC 12V	<input type="checkbox"/> 3000K/90+ <input type="checkbox"/> 4000K/90+ <input type="checkbox"/> 5000K/90+	<input type="checkbox"/> White <input type="checkbox"/> Black <input type="checkbox"/> Brown

*Other special requirements please confirm with our factory



Liteharbor Lighting Technology Co., Ltd.

New Industry Area Hecun Danzao Town
Nanhai Foshan City Guangdong China

TEL: +86-757-8180 8687

FAX: +86-757-8180 8685

E-mail: info@liteharbor.com

Website: www.liteharbor.com

Specifications subject to change w/o notice

Revision: Jul. 2019