

# BL2-S001-NC LED DOWNLIGHT

<b>Catalog #</b>		<b>Prepared by</b>	LiteHarbor
<b>Project</b>		<b>Date</b>	
<b>Notes</b>			

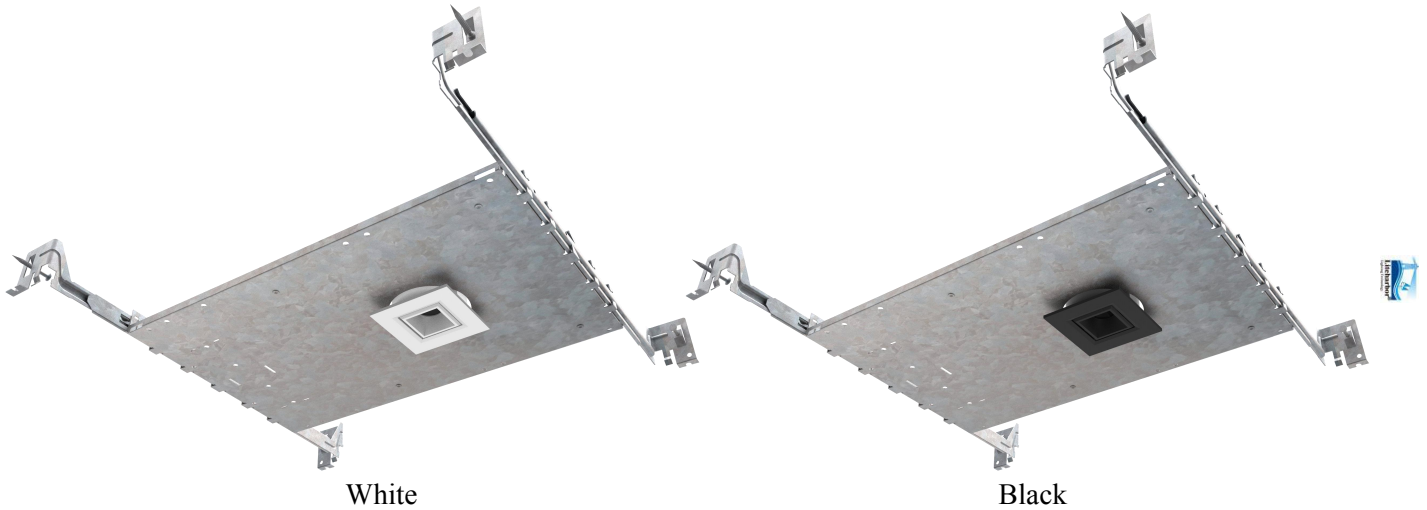

## New Construction 2 Inch Light Emitting Surface Square Miniature LED Recessed Downlight

### Features

- The simplified retrofit installation can be used in both new and existing spaces.
- IC Airtight for use with direct contact to insulation.
- Beam Angle: 30/60/90 Degrees.
- Life Rated for 50,000 hours at 70% lumen maintenance.
- Easy installation for new construction and remodel applications.

### Specification

- Source: LED COB Chips.
- Lumen maintenance: 50,000 hours L70 based on LM80 standardized test results.
- Optics: PC Lens for even lumen distribution.
- Material: Die-cast aluminum construction for lasting quality.
- Mounting: New construction installation or remodel installation
- Electrical: High efficiency electronic driver, rated at 50 000 hours
- Heat dissipation: Superior Thermal Management by utilizing aluminum body as heat sink.
- Warranty: 3 year limited warranty.

LED DOWNLIGHT



**Liteharbor Lighting Technology Co., Ltd.**  
New Industry Area Hecun Danzao Town  
Nanhai Foshan City Guangdong China

TEL: +86-757-8180 8687  
FAX: +86-757-8180 8685  
E-mail: info@liteharbor.com

Website: www.liteharbor.com  
Specifications subject to change w/o notice  
Revision: Jul. 2019

## Listing / Warranty

ETL listed to US and Canadian standards for damp location W/Feed through.

3 Year Limited Warranty.

## Applications

Suitable for jewelry stores, boutiques, luxury goods stores, shopping malls and other places that require concentrated lighting and accent lighting.

## Parameter

Voltage	AC/DC 12V
Frequency	60 Hz
Watt	8W
Driver	Liteharbor
Dimmable	Non-dimming
Lumen	800-1000lm
Light Source	COB
CRI	90+
Beam Angle	30D/60D/90D
CCT	2700K-5000K
Material	Aluminum
Finish	White/Black/Brown



LED DOWNLIGHT



**Liteharbor Lighting Technology Co., Ltd.**

New Industry Area Hecun Danzao Town  
Nanhai Foshan City Guangdong China

TEL: +86-757-8180 8687

FAX: +86-757-8180 8685

E-mail: [info@liteharbor.com](mailto:info@liteharbor.com)

Website: [www.liteharbor.com](http://www.liteharbor.com)

Specifications subject to change w/o notice

Revision: Jul. 2019

## Dimensions

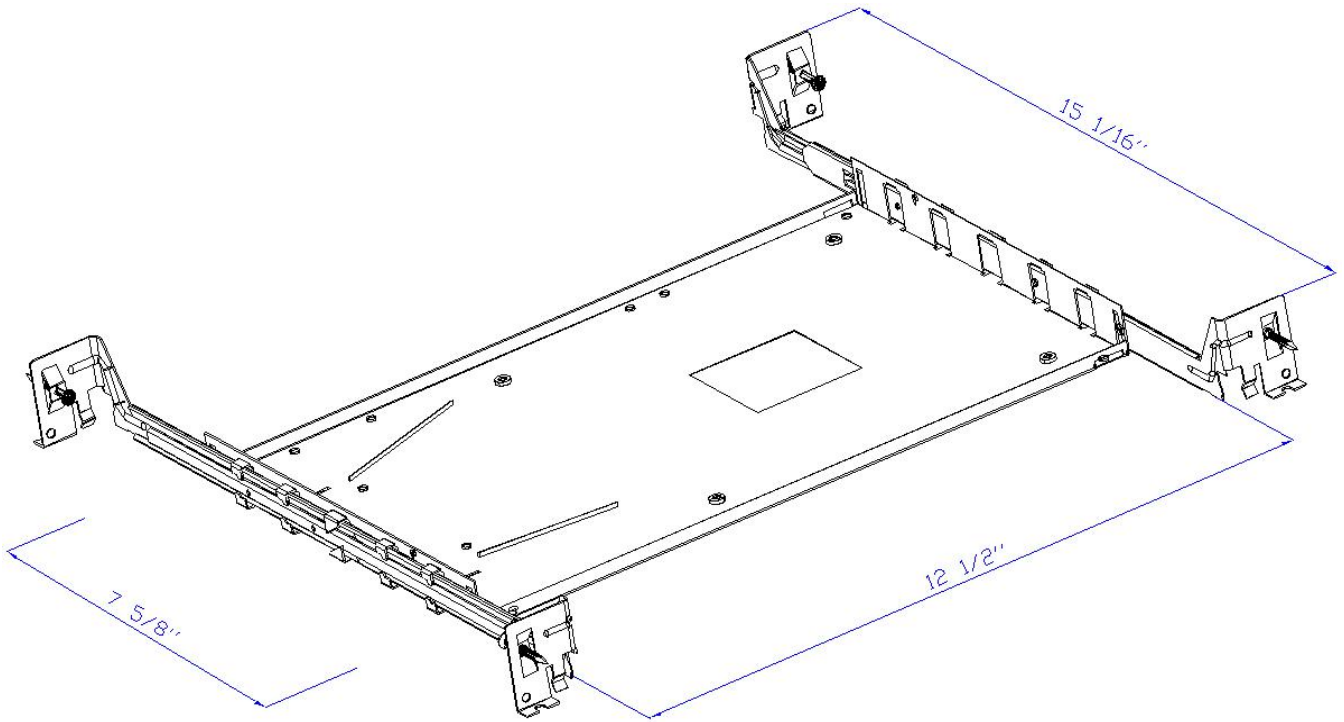

## Trim Option

Option ①: Color



White

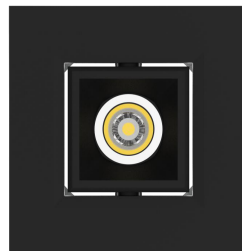

Black

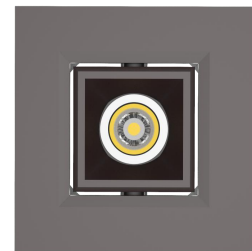

Brown

Option ②: Smooth Trim

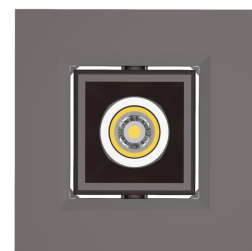
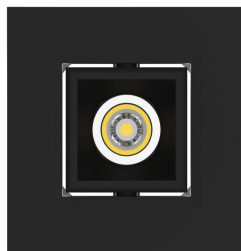

LED DOWNLIGHT



**Liteharbor Lighting Technology Co., Ltd.**  
New Industry Area Hecun Danzao Town  
Nanhai Foshan City Guangdong China

TEL: +86-757-8180 8687  
FAX: +86-757-8180 8685  
E-mail: info@liteharbor.com

Website: www.liteharbor.com  
Specifications subject to change w/o notice  
Revision: Jul. 2019

Option ③: Baffle Trim

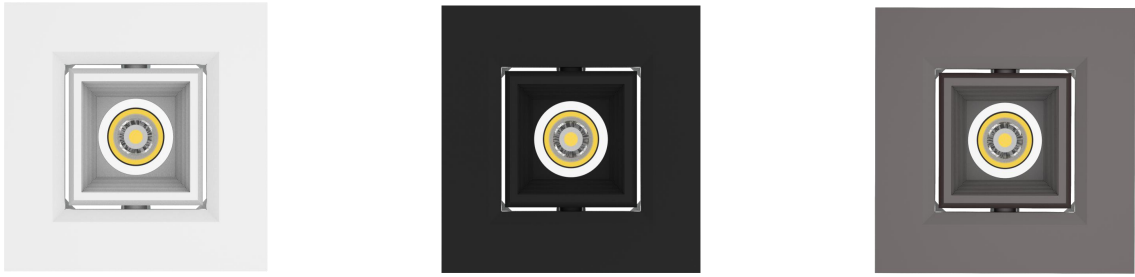

Structure Elucidation

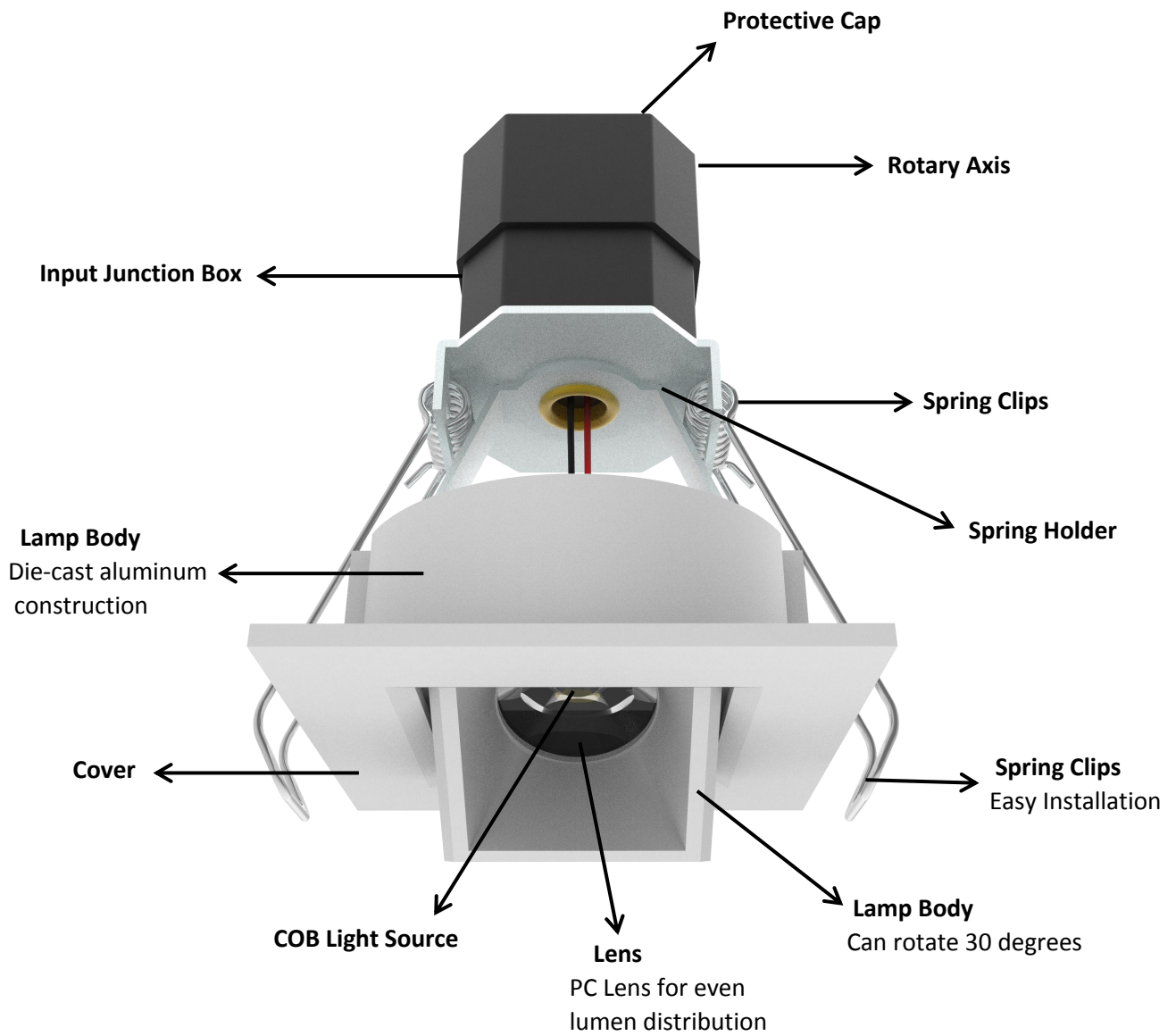

LED DOWNLIGHT



**Liteharbor Lighting Technology Co., Ltd.**  
New Industry Area Hecun Danzao Town  
Nanhai Foshan City Guangdong China

TEL: +86-757-8180 8687  
FAX: +86-757-8180 8685  
E-mail: info@liteharbor.com

Website: www.liteharbor.com  
Specifications subject to change w/o notice  
Revision: Jul. 2019

## Ordering Guide

Series/Lumen	Input Voltage	CCT/CRI	Finish
<input type="checkbox"/> BL2-S001-NC LED Downlight	<input type="checkbox"/> AC 12V <input type="checkbox"/> DC 12V	<input type="checkbox"/> 3000K/90+ <input type="checkbox"/> 4000K/90+ <input type="checkbox"/> 5000K/90+	<input type="checkbox"/> White <input type="checkbox"/> Black <input type="checkbox"/> Brown

\*Other special requirements please confirm with our factory



**Liteharbor Lighting Technology Co., Ltd.**

New Industry Area Hecun Danzao Town  
Nanhai Foshan City Guangdong China

TEL: +86-757-8180 8687

FAX: +86-757-8180 8685

E-mail: [info@liteharbor.com](mailto:info@liteharbor.com)

Website: [www.liteharbor.com](http://www.liteharbor.com)

Specifications subject to change w/o notice

Revision: Jul. 2019